

Model 17, 18, 19 Series



Model 17 & 18
Shown with optional mounting bracket MB-18



Model 19

CR Magnetics offers a versatile line of rugged wire lead current transformers. Installed around a current-carrying wire, the sensor provides a current output relative to the AC input current (within specification limits). With the output connected across a resistive load (burden), the voltage developed is proportional to the input current.

Applications

- Remote monitoring of electrical loads
- Input to electrical control system
- Detect open heater elements
- Indicate phase loss
- Monitor motor operation

Features

- Low cost
- Non-contact, isolated current measurement
- Surface mounting bracket available for Models 17 and 18
- Two case sizes, three different standard ratios

Specifications

- Frequency: 50-60 Hz
- Case Material: Black thermoplastic
- Maximum Continuous Primary Current 4 X I_r
- Insulation Voltage 3500 Vac/1min

Regulatory Agencies



ORDER INFORMATION

Part Number	Description
Model 17-2000	Current Transformer with wire leads, .55 dia. opening, 2000 turns
Model 17-1000	Current Transformer with wire leads, .55 dia. opening, 1000 turns
Model 18-600	Current Transformer with wire leads, .55 dia. opening, 600 turns
MB-18	Surface Mounting Bracket for Model 17 or Model 18
Model 19	Current Transformer with .29 dia. opening, 230 turns

BASIC SPECIFICATIONS

Part Number	I _{max}	V _{max}	T _e (typ.)	DCR Ω	Frequency
Model 17-2000	200	10	2010	120	50 - 2KHz
Model 17-1000	200	7.5	1010	31	50 - 2KHz
Model 18-600	100	5	605	23	50 - 2KHz
Model 19	25	2	235	3	50 - 2KHz

I_r = Maximum AC Input Current to be linearly sensed V_{max} = Maximum VAC (Saturation) CT will develop

T_e = Effective turns ratio including losses (+/- 10%) (All Specifications tested at 60 Hz)

Outline Drawings

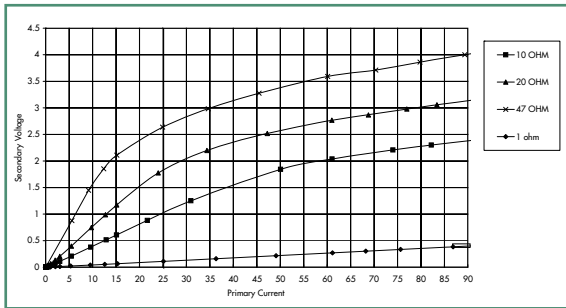

Model 19 - 230 Turns

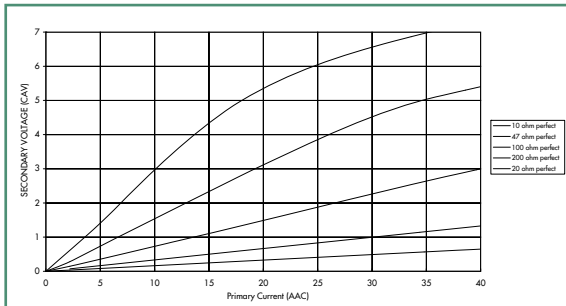

Model 18 - 600 Turns

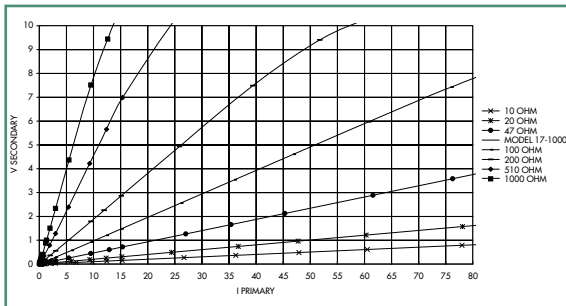

Model 17 - 1000 Turns

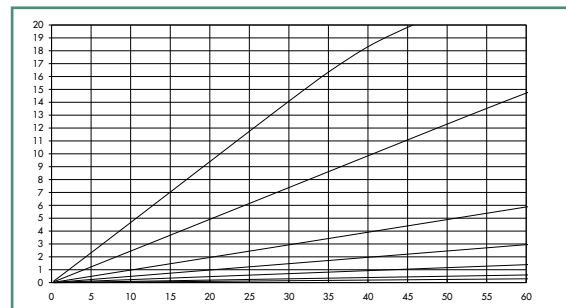

Model 17 - 2000 Turns

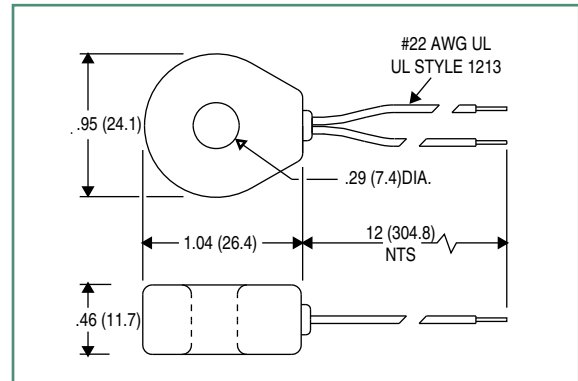

Model 19:
Current Sensing Transformer

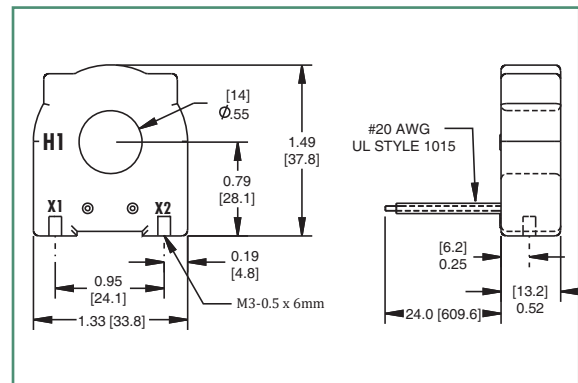

Model 17 & 18:
Current Sensing Transformers
Also available with PCB pins

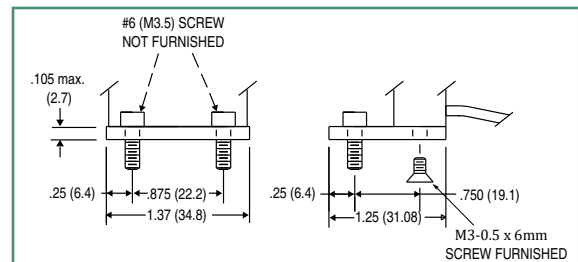

MB-18: Surface Mounting Bracket
for Model 17 & Model 18